



# High Performance Step-Down DC-DC Converter With Adjustable Output Voltage

## FEATURES

- 2-MHz PWM Operation
- Integrated MOSFET Switches
- 2.6-V to 6.0-V Input Voltage Range
- Minimal Number of External Components
- Up to 96% conversion efficiency
- 600-mA Load Capability
- 100% Duty Cycle Allows Low Dropout
- Integrated Compensation Circuit
- Over-Current Protection
- Shutdown Current < 2  $\mu$ A
- Thermal Shutdown
- Integrated UVLO
- 10-Pin MSOP and Space Saving MLP33 Packaging

- User Selectable PWM, PSM, or AUTO Mode
- PSM Frequency  $\geq$  20 kHz for Inaudible Harmonics

## APPLICATIONS

- W-CDMA Cell Phone
- PDAs/Palmtop PCs
- LCD Modules
- Portable Image Scanners
- GPS Receivers
- Smart Phones
- MP3 Players
- 3G Cell Phone
- Digital Cameras

## DESCRIPTION

The Si9176 is a high efficiency 600-mA step down converter with internal low on resistance power MOSFET switch and synchronous rectifier transistors. It is designed to convert one cell Lilon battery or three cell alkaline battery voltages to a dynamically adjustable dc output. The integrated high frequency error amplifier with internal compensation minimizes external components.

2-MHz switching permits use of small external inductor and capacitor sizes allowing *one of the smallest solutions*.

PSM mode provides increased efficiency at light loads. In PSM mode the oscillator frequency is kept above 20 kHz to avoid audio band interference. When operating in Auto mode, the converter automatically selects operating in either PWM or PSM mode according to load current demand.

In order to insure efficient conversion throughout the entire load range, PWM (pulse width modulation), PSM (pulse skipping mode) or Auto mode can be selected. In PWM mode,

The Si9176 is available in 10-pin MSOP and even smaller MLP33 packages and is specified to operate over the industrial temperature range of  $-40^{\circ}\text{C}$  to  $85^{\circ}\text{C}$ .

## TYPICAL APPLICATIONS CIRCUIT

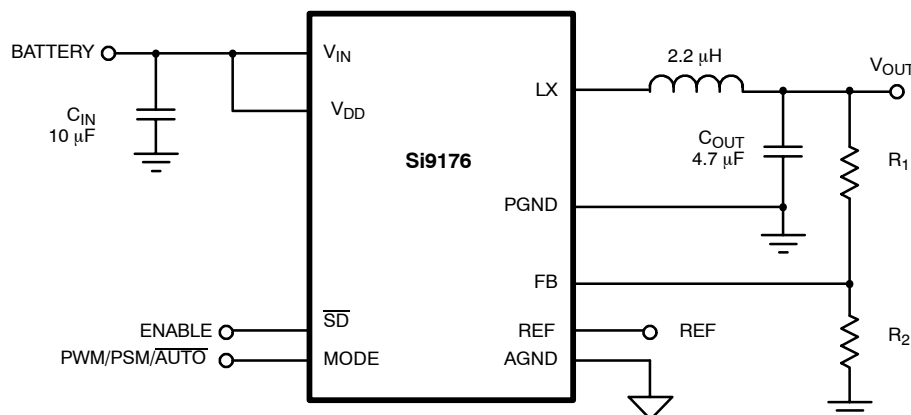

## ABSOLUTE MAXIMUM RATINGS

Voltages Referenced to AGND = 0 V	
$V_{IN}, V_{DD}$	6.2 V
Lx, $\overline{SD}$ , MODE, FB, $C_{REF}$	-0.3 to 6.2 V (or to $V_{DD} + 0.3$ V whichever is less)
GND	-0.3 to +0.3 V
ESD Rating	2 kV
Storage Temperature	-65 to 125°C
Operating Junction Temperature	150°C
Power Dissipation (Package) <sup>a</sup>	
10-pin MSOP <sup>b</sup>	481 mW
10-pin MLP33	915 mW

Thermal Impedance ( $\Theta_{JA}$ )	
10-Pin MSOP	135°C/W
10-Pin MLP33	71°C/W
Peak Inductor Current	1.8 A

## Notes

- Device mounted with all leads soldered or welded to PC board.
- Derate 7.4 mW/°C above 85°C.
- Derate 14 mW/°C above 85°C.

Stresses beyond those listed under "Absolute Maximum Ratings" may cause permanent damage to the device. These are stress ratings only, and functional operation of the device at these or any other conditions beyond those indicated in the operational sections of the specifications is not implied. Exposure to absolute maximum rating conditions for extended periods may affect device reliability.

## RECOMMENDED OPERATING RANGE

$V_{IN}$ Range	2.6 V to 5.5 V
$C_{IN}$	10 $\mu$ F Ceramic
$C_{OUT}$	4.7 $\mu$ F Ceramic

Inductor	2.2 $\mu$ H
Operating Load Current PWM Mode	0 to 600 mA
Operating Load Current PSM Mode	0 to 150 mA

## SPECIFICATIONS

Parameter	Mode <sup>f</sup>	Symbol	Test Conditions Unless Specified -40°C to 85°C, $V_{IN} = V_{DD}$ , $C_{IN} = 10 \mu$ F, $C_{OUT} = 4.7 \mu$ F $L = 2.2 \mu$ H, $2.6 \text{ V} \leq V_{IN} \leq 5.5 \text{ V}$ , $R_1 = 11.3 \text{ k}\Omega$ , $R_2 = 20 \text{ k}\Omega$	Limits			Unit	
				Min <sup>a</sup>	Typ <sup>b</sup>	Max <sup>a</sup>		
<b>Under Voltage Lockout (UVLO)</b>								
Under Voltage Lockout (turn-on)			$V_{IN}$ rising	2.3		2.5	V	
Hysteresis					0.1			
<b>Shutdown (<math>\overline{SD}</math>)</b>								
Logic HIGH		$V_{SDH}$		1.6			V	
Logic LOW		$V_{SDL}$				0.4		
Delay to Output <sup>c</sup>		$t_{en}$	Settle Within $\pm 2\%$ accuracy $\overline{SD}$ rising $t_r < 1 \mu$ s	$R_L = 3.3 \Omega$		100	$\mu$ s	
				$R_L = 51 \Omega$		100		
Pull Down		$I_{SD}$	Input at $V_{IN}$				$\mu$ A	
<b>Mode Selection Tri-Level Logic (MODE)</b>								
MODE Pin HIGH	PWM			$V_{IN} - 0.4$	$V_{IN}$		V	
MODE Pin LOW	Auto					0.4		
Mode Pin Input Current			MODE = GND		-5		$\mu$ A	
			MODE = $V_{IN}$		5			
<b>Oscillator</b>								
Frequency		$f_{osc}$		1.6	2	2.4	MHz	
<b>Error Amplifier (FB Pin)</b>								
FB Voltage Accuracy		$V_{FB}$		$T_A = 25^\circ\text{C}$	1.190	1.215	1.240	V
				$T_A = -40 \text{ to } 85^\circ\text{C}$	1.173		1.257	
Power Supply Rejection		PSRR	$V_{IN} = 2.6 \text{ V to } 5.5 \text{ V}_{DC}$		60		db	
Input Bias Current		$I_{FB}$	$V_{FB} = 1.25 \text{ V}$	-1	0.01	1	$\mu$ A	



SPECIFICATIONS								
Parameter	Mode <sup>f</sup>	Symbol	Test Conditions Unless Specified -40°C to 85°C, V <sub>IN</sub> = V <sub>DD</sub> , C <sub>IN</sub> = 10 μF, C <sub>OUT</sub> = 4.7 μF L = 2.2 μH, 2.6 V ≤ V <sub>IN</sub> ≤ 5.5 V, R <sub>1</sub> = 11.3 kΩ, R <sub>2</sub> = 20 kΩ		Limits			Unit
					Min <sup>a</sup>	Typ <sup>b</sup>	Max <sup>a</sup>	
<b>Converter Operation</b>								
Maximum Output Current	PWM	I <sub>LOAD</sub>	V <sub>IN</sub> = 3.6 V		600			mA
Maximum Output Current	PSM	I <sub>LOAD</sub>	V <sub>IN</sub> = 3.6 V				150	mA
Dropout Voltage <sup>e</sup>		V <sub>DD</sub>	V <sub>IN</sub> = 2.6 V, I <sub>OUT</sub> = 600 mA			190	300	mV
Closed Loop Bandwidth		BW				300		kHz
Load Regulation <sup>c</sup>	PWM		V <sub>IN</sub> = 3.6 V V <sub>OUT</sub> = 1.9 V @ 25°C	I <sub>OUT</sub> = 30 mA to 600 mA		0.5		%
	PSM			I <sub>OUT</sub> = 30 mA to 75 mA		0.25		
Line Regulation	PWM		V <sub>OUT</sub> = 3.0 V, V <sub>IN</sub> = 3.5 V to 5.5 V			± 0.1		%V
	PSM					± 0.1		
PWM/PSM Switch Threshold Current		I <sub>AUpk</sub>				200		mA
Maximum Inductor Peak Current Limit		I <sub>Lpk</sub>				1500		
On Resistance	P-Channel	r <sub>DS(on)</sub>	V <sub>IN</sub> = 3.6 V			250		mΩ
	N-Channel					250		
Output Ripple Voltage	PWM		0.05 Ω C <sub>OUT</sub> (ESR)	I <sub>OUT</sub> = 600 mA		60		mV <sub>p-p</sub>
	PSM			I <sub>OUT</sub> = 30 mA		80		
Efficiency	PWM		V <sub>IN</sub> = 3.6 V, V <sub>OUT</sub> = 3.3 V	I <sub>OUT</sub> = 600 mA		90		%
	PSM			I <sub>OUT</sub> = 30 mA		80		
Frequency	PSM		I <sub>OUT</sub> ≥ 30 mA		20			kHz
<b>Supply Current</b>								
Input Supply Current	PWM	I <sub>SUPPLY</sub> (V <sub>DD</sub> & V <sub>IN</sub> )	I <sub>OUT</sub> = 0 mA, V <sub>IN</sub> = 3.6 V (not switching, FB = GND)			450	750	μA
	PSM					400		
Shutdown Supply Current		I <sub>SD</sub>	SD = Low				2	
<b>Thermal Shutdown</b>								
Thermal Shutdown Temperature <sup>c</sup>		T <sub>J(S/D)</sub>				165		°C
Thermal Hysteresis <sup>c</sup>						20		

Notes

- a. The algebraic convention whereby the most negative value is a minimum and the most positive a maximum, is used in this data sheet.
- b. Typical values are for DESIGN AID ONLY, not guaranteed or subject to production testing.
- c. Guaranteed by design.
- d. Settling times, t<sub>s</sub>, apply after t<sub>en</sub>.
- e. Bypass is a device mode of operation, in which, the device is in 100% duty cycle. Bypass operation is possible in either PWM or PSM.
- f. Operating modes are controlled with the MODE pin where Auto mode = MODE = LOW, PWM Mode = MODE = HIGH, and PSM mode = MODE = OPEN.

**PIN CONFIGURATION**

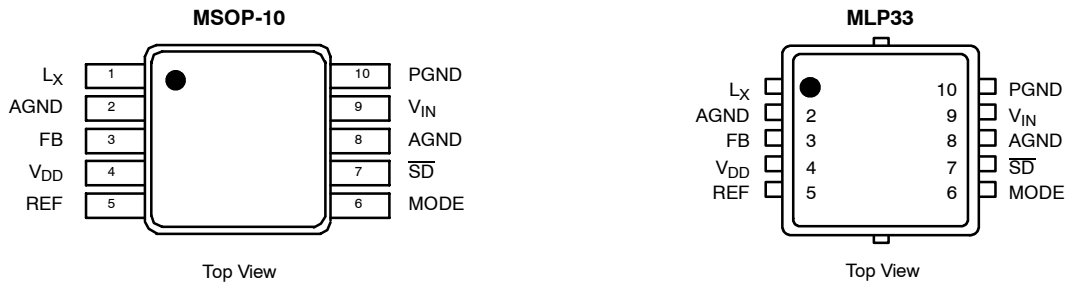

**PIN DESCRIPTION**

Pin Number	Name	Function
1	L <sub>X</sub>	Inductor connection
2	AGND	Low power analog ground
3	FB	Output voltage feedback
4	V <sub>DD</sub>	Input supply voltage for the analog circuit.
5	REF	Internal reference, no connection should be made to this pin.
6	MODE	Used to select switching mode of the buck converter PWM/PSM Pin Logic: <b>MODE Pin</b> <b>Operating Mode</b> V <sub>IN</sub> PWM Open                                PSM GND                                AUTO
7	$\overline{SD}$	Logic low disables IC and reduces quiescent current to below 2 $\mu$ A
8	AGND	Must be connected to AGND.
9	V <sub>IN</sub>	Input supply voltage
10	PGND	Low impedance power ground

**ORDERING INFORMATION**

MSOP-10			MLP33		
Part Number	Marking	Temperature	Part Number	Marking	Temperature
Si9176DH-T1	9176	-40 to 85°C	Si9176DM-T1	9176	-40 to 85°C

Additional voltage options are available.

Eval Kit	Temperature Range	Board
Si9176DB	-40 to 85°C	Surface Mount

**FUNCTIONAL BLOCK DIAGRAM**

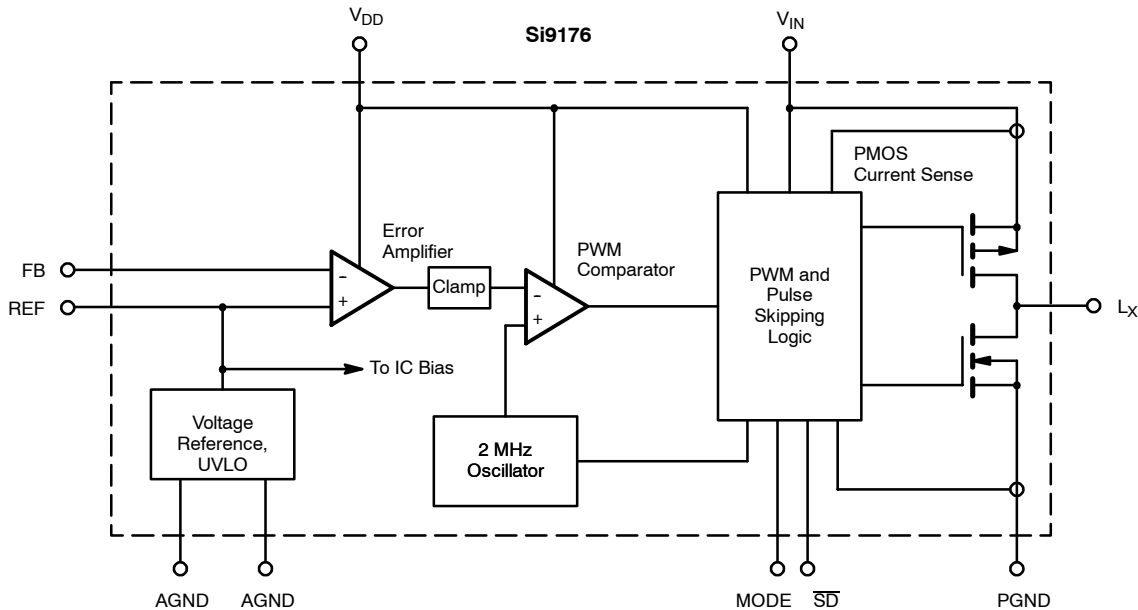

**DETAIL DESCRIPTION**

**General**

The Si9176 is a high efficiency synchronous dc-dc converter that is ideally suited for lithium ion battery or three cell alkaline applications, as well as step-down of 3.3-V or 5.0-V supplies. The major blocks of the Si9176 are shown in the Functional Block Diagram. The 0.25-Ω internal MOSFETs switching at a frequency of 2-MHz minimize PC board space while providing high conversion efficiency and performance. The high frequency error-amplifier with built-in loop compensation minimizes external components and provides rapid output settling times of <30 μs. Sensing of the inductor current for control is accomplished internally without power wasting resistors.

**Start-Up**

When voltage is applied to  $V_{IN}$  and  $V_{DD}$ , the under-voltage lockout (UVLO) circuit prevents the oscillator and control circuitry from turning on until the voltage on the exceeds 2.4 V. With a typical UVLO hysteresis of 0.1 V, the converter operates continuously until the voltage on  $V_{IN}$  drops below 2.3 V, whereupon the converter shuts down. This hysteresis prevents false start-stop cycling as the input voltage approaches the UVLO switching threshold. Start-up is always accomplished in PWM mode to ensure start-up under all load

conditions. Switching to other modes of operation occurs according to the state of the MODE pin and the load current. The start-up sequence occurs after  $\overline{SD}$  switches from LOW to HIGH with  $V_{IN}$  applied, or after  $V_{IN}$  rises above the UVLO threshold and  $\overline{SD}$  is a logic HIGH.

**Mode Control (MODE)**

The MODE pin allows the user to control the mode of operation or to enable the Si9176 to automatically optimize the mode of operation according to load current. There are three different modes of operation as controlled by the MODE pin. Switching waveforms are shown in the [Typical Switching Waveform](#) sections, page 9.

**PWM Mode (MODE pin = HIGH)**

With the MODE pin in the logic HIGH condition, the Si9176 operates as a 2-MHz fixed frequency voltage mode converter. A NMOS synchronous rectification MOSFET transistor provides very high conversion efficiency for large load currents by minimizing the conduction losses. PWM mode provides low output ripple, fast transient response, and switching frequency synchronization. Output load currents can range from 0 to 600 mA.

The error amplifier and comparator control the duty cycle of the PMOS MOSFET to continuously force the REF pin and FB pin voltages to be equal. As the input-to-output voltage difference drops, the duty cycle of the PMOS MOSFET can reach 100% to allow system designers to extract the maximum stored energy from the battery. The dropout voltage is 190 mV at 600 mA.

During each cycle, the PMOS switch current is limited to a maximum of 1.5 A (typical) thereby protecting the IC while continuing to force maximum current into the load.

#### Pulse Skipping Mode (MODE pin = OPEN)

By leaving the MODE pin open-circuit, the converter runs in pulse skipping mode (PSM). In PSM mode the oscillator continues to operate, but switching only occurs if the FB pin voltage is below the REF voltage at the start of each clock cycle. Clock cycles are skipped thereby reducing the switching frequency to well below 100 kHz and minimizing switching losses for improved efficiency at loads under 150 mA. Although PSM mode switching frequency varies with line and load conditions, the minimum PSM frequency will be kept above 20 kHz for load currents of 30 mA or more to prevent switching noise from reaching the audio frequency range.

Each time the PMOS switch is turned on, the inductor current is allowed to reach 300 mA. Once achieved, the PMOS switch is turned off and the NMOS switch is turned on in the normal manner. However, unlike PWM mode, the NMOS switch, turns off as the switch current approaches zero current to maximize efficiency. The PMOS switch remains on continuously (100% duty cycle) when the input-voltage-to-output-voltage difference is low enabling maximum possible energy extraction from the battery.

PSM mode is recommend for load currents of 150 mA or less.

#### Auto Mode

When the MODE pin grounded, the converter is set to Auto mode. Switching between PWM mode and PSM modes takes place automatically without an external control signal. For heavy load operation, the converter will operate in PWM mode to achieve maximum efficiency. When delivering light load

currents, the converter operates in PSM mode to conserve power. The switchover threshold between the two modes is determined by the peak inductor current, which is 300 mA nominal. There is hysteresis in the switchover threshold to provide smooth operation. Thus, the mode PSM-to-PWM mode switchover current for increasing load currents is higher than that of PWM-to-PSM mode switchover for decreasing load currents.

#### Oscillator

The internal oscillator provides for a fixed 2-MHz switching frequency.

#### Dynamic Output Voltage Control (REF)

The Si9176 is designed with an adjustable output voltage which has a change of  $V_{FB}$  to  $V_{IN} - V_{DROP}$ .  $V_{OUT}$  is defined according to the following relationship:

$$V_{OUT} = \left( 1 + \frac{R_1}{R_2} \right) \times V_{FB}$$

#### Converter Shutdown ( $\overline{SD}$ pin)

With logic LOW level on the  $\overline{SD}$  pin, the Si9176 is shutdown. Shutdown reduces current consumption to less than 2- $\mu$ A by shutting off all of the internal circuits. Both the PMOS and NMOS transistors are turned off. A logic HIGH enables the IC to start up as described in "Start-up" section.

#### Thermal Shutdown

The Si9176 includes thermal shutdown circuitry, which turns off the regulator when the junction temperature exceeds 165°C. Once the junction temperature drops below 145°C, the regulator is enabled. If the condition causing the over temperature, the Si9176 begins thermal cycling, turning the regulator on and off in response to junction temperature. Restart from a thermal shutdown condition is the same as described in the "Start-up" section.

**APPLICATIONS CIRCUIT**

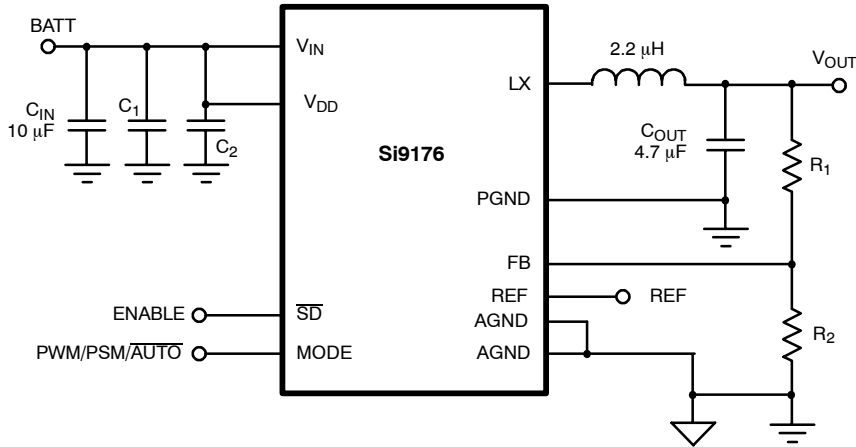

$C_{IN} = 10 \mu\text{F}$ , Ceramic, Murata GRM42-2X5R106K16  
 $C_1, C_2 = 0.01 \mu\text{F}$ , Vishay VJ0603Y 104KXXAT  
 $C_{OUT} = 4.7 \mu\text{F}$ , Ceramic, Murata GRM42-6X5R475K16  
 $R_1 = 8.2 \text{ k}\Omega$ , Vishay CRCW06031132F  
 $R_2 = 20 \text{ k}\Omega$ , Vishay CRCW06032002F  
 $L_1 = 2.2 \mu\text{H}$ , Toko A914BYW-2R2M

**TYPICAL CHARACTERISTICS**

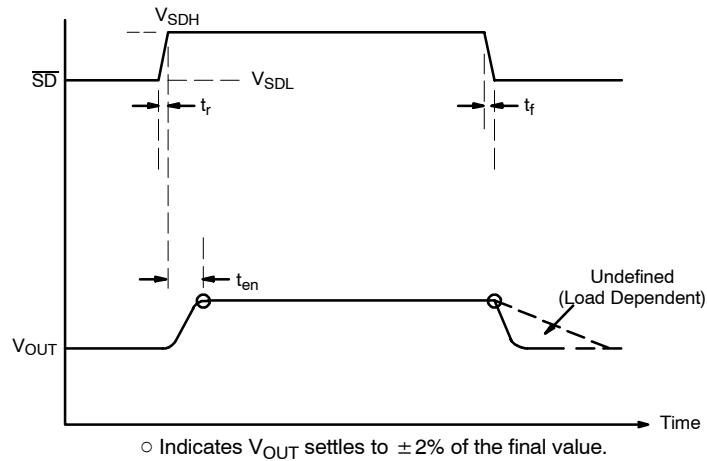
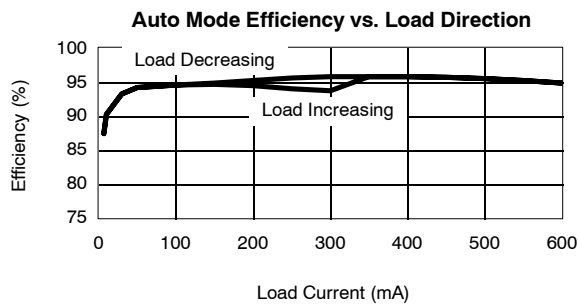
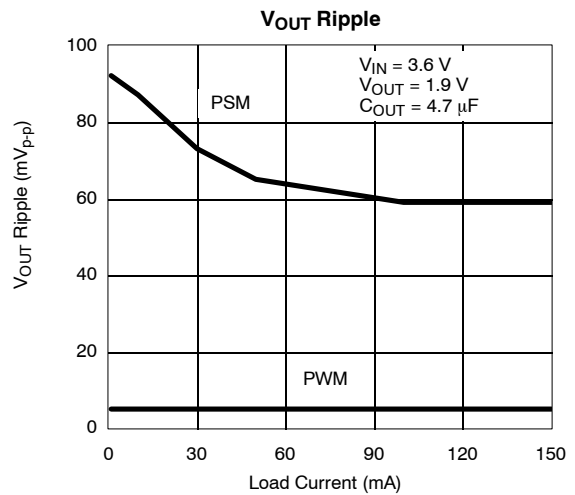
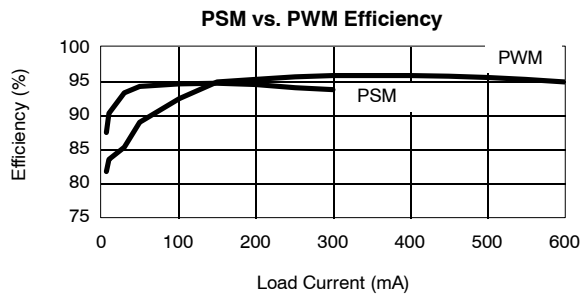
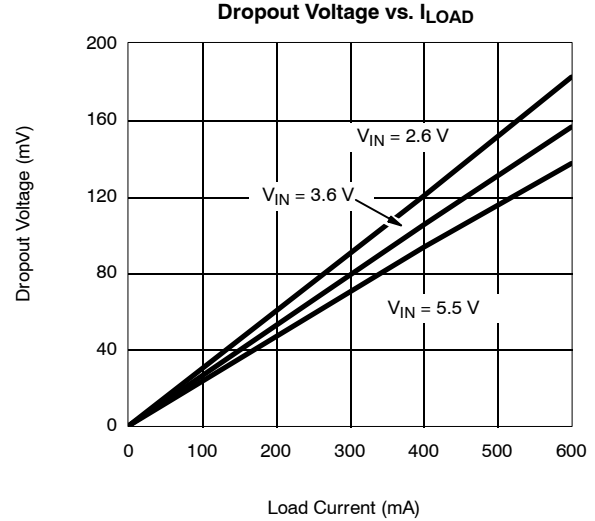
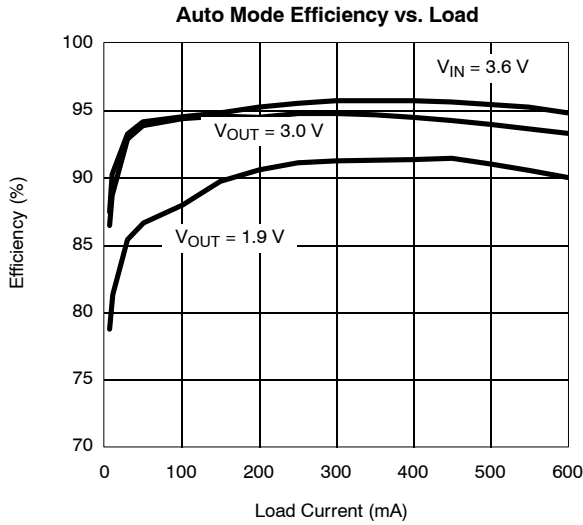

Figure 1. PWM Mode  $V_{OUT}$  Settling

**TYPICAL CHARACTERISTICS**





**TYPICAL SWITCHING WAVEFORMS ( $V_{IN} = 3.6\text{ V}$ ,  $V_{OUT} = 3.0\text{ V}$ )**

PWM mode Heavy-Load Switching Waveforms,  
 $I_{OUT} = 600\text{ mA}$ , MODE = HIGH

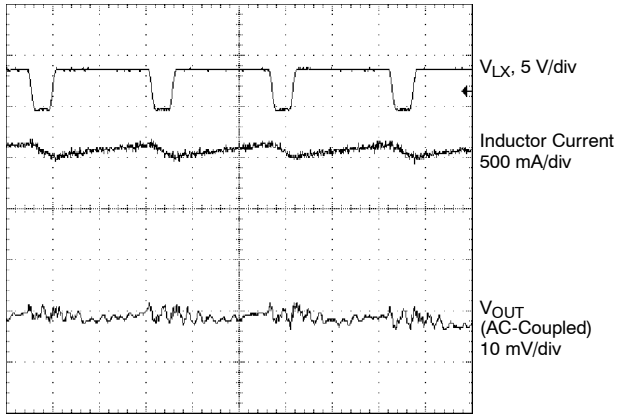

200 nS/div

PWM Mode Medium-Load Switching Waveforms,  
 $I_{OUT} = 300\text{ mA}$ , MODE = HIGH

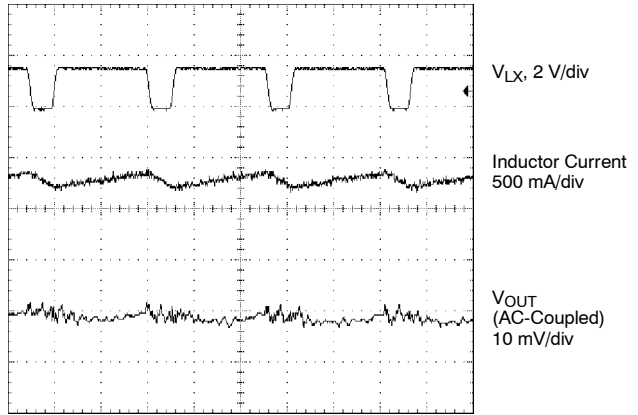

200 nS/div

PWM Mode Light-Load Switching Waveforms,  
 $I_{OUT} = 0\text{ mA}$ , MODE = HIGH

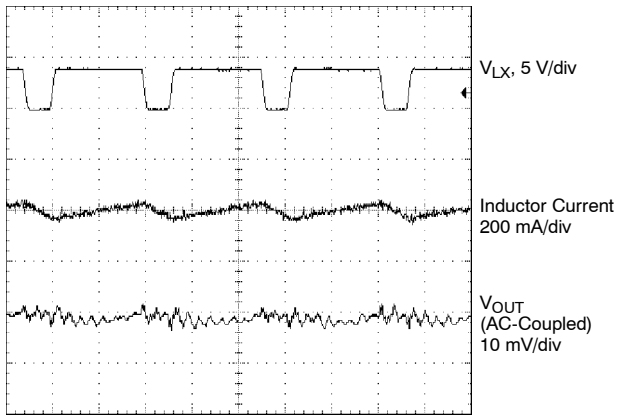

200 nS/div

PSM Mode Light-Load Switching Waveforms,  
 $I_{OUT} = 150\text{ mA}$ , MODE = OPEN

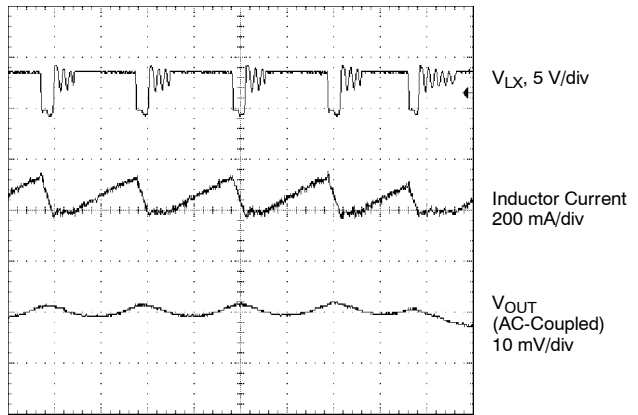

1.0 μS/div

PSM Mode Light-Load Switching Waveforms,  
 $I_{OUT} = 30\text{ mA}$ , MODE = OPEN

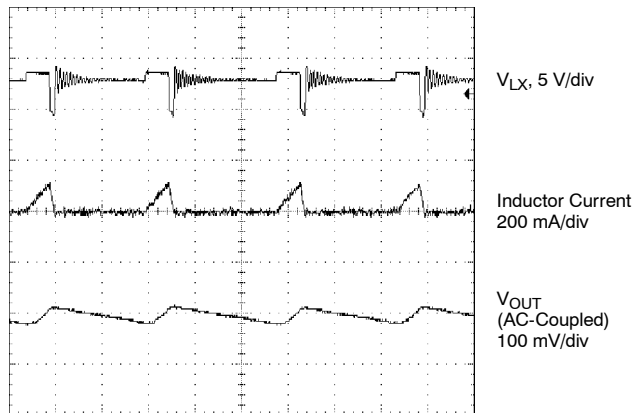

2.0 μS/div

**TYPICAL WAVEFORMS ( $V_{IN} = 3.6\text{ V}$ ,  $V_{OUT} = 1.9\text{ V}$ )**

PWM Mode Heavy-Load Switching Waveforms,  
 $I_{OUT} = 600\text{ mA}$ , MODE = HIGH

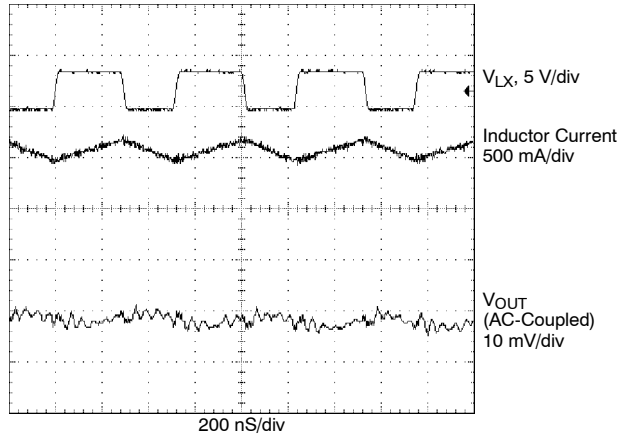

PWM Mode Medium-Load Switching Waveforms,  
 $I_{OUT} = 300\text{ mA}$ , MODE = HIGH

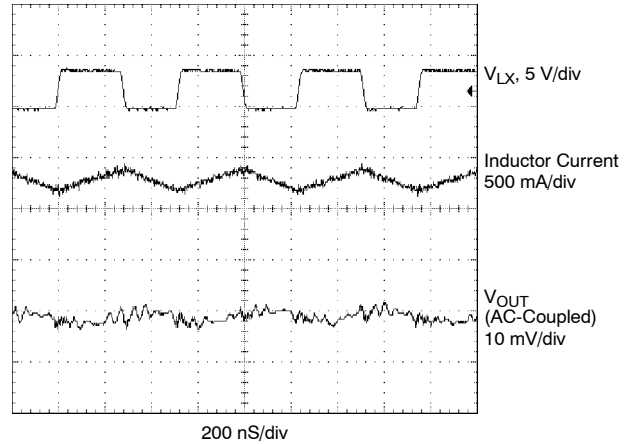

PWM Mode Light-Load Switching Waveforms,  
 $I_{OUT} = 0\text{ mA}$ , MODE = HIGH

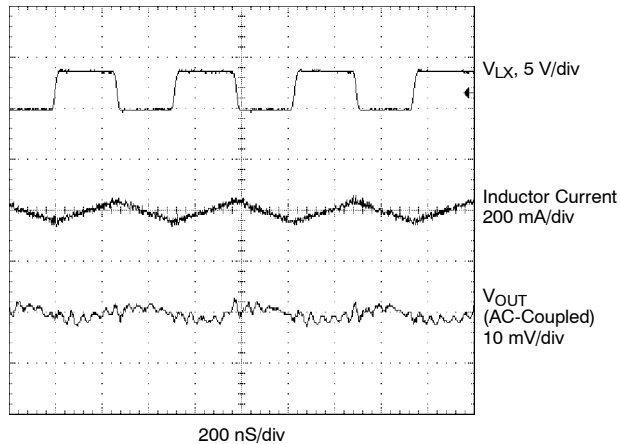

PSM Mode Light-Load Switching Waveforms,  
 $I_{OUT} = 150\text{ mA}$ , MODE = OPEN

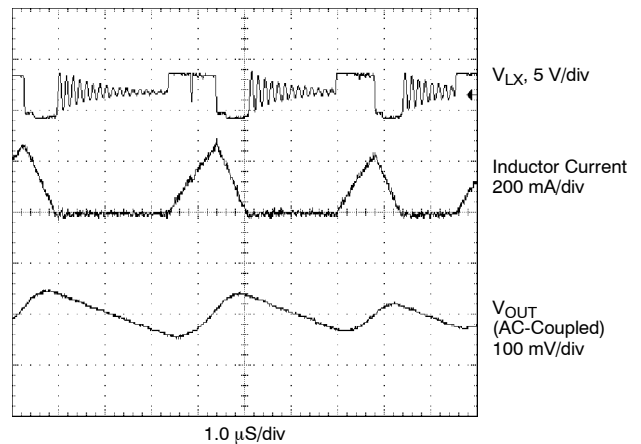

PSM Mode Light-Load Switching Waveforms,  
 $I_{OUT} = 30\text{ mA}$ , MODE = OPEN

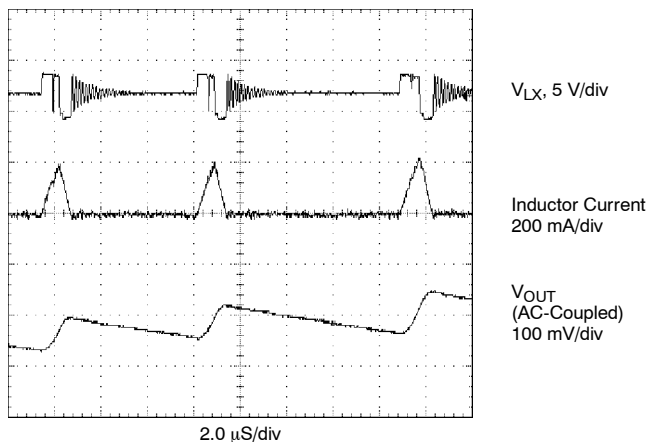

**TYPICAL START-UP AND SHUTDOWN TRANSIENT WAVEFORMS ( $V_{IN} = 3.6\text{ V}$ ,  $V_{OUT} = 1.9\text{ V}$ )**

Start-Up,  $R_{LOAD} = 4\ \Omega$

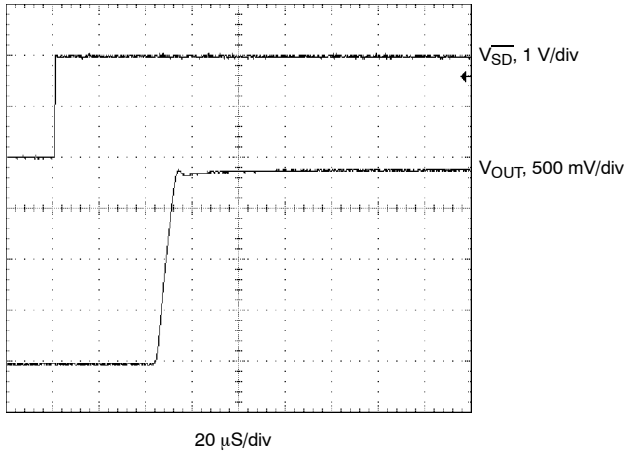

Start-Up,  $V_{IN} = V_{SD} = 3.6\text{ V}$ ,  $R_{LOAD} = 4\ \Omega$

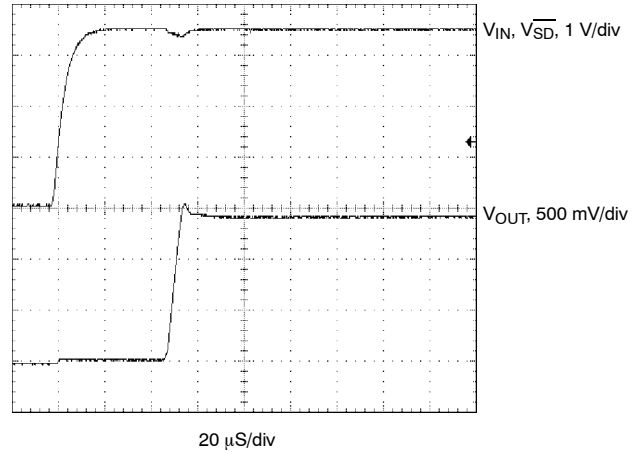

Shutdown,  $R_{LOAD} = 4\ \Omega$

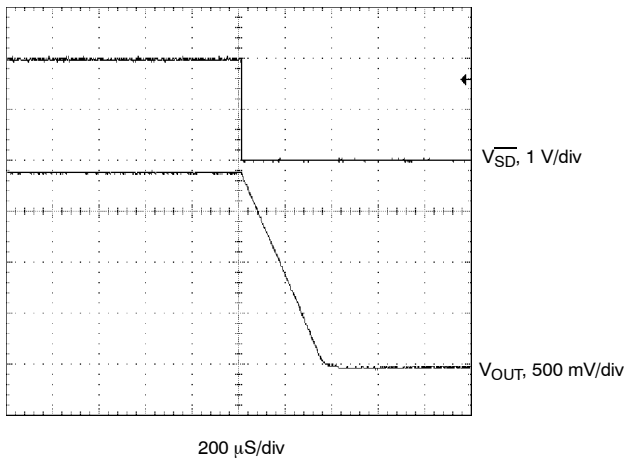

Enable Switching,  $R_{LOAD} = 4\ \Omega$

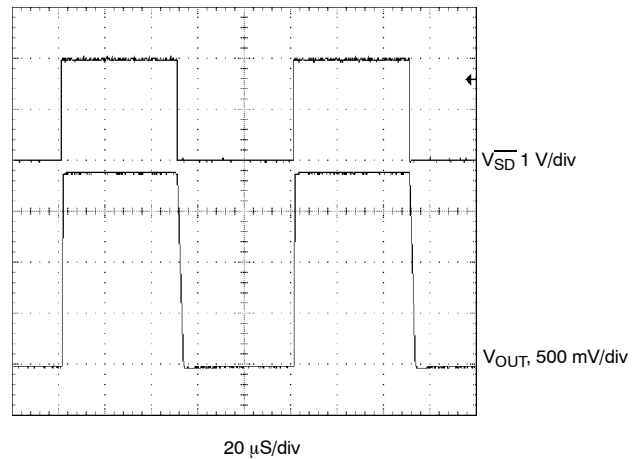

**TYPICAL MODE SWITCH TRANSIENT WAVEFORM**

Output Transient At Mode Switch,  $I_{LOAD} = 30\text{ mA}$

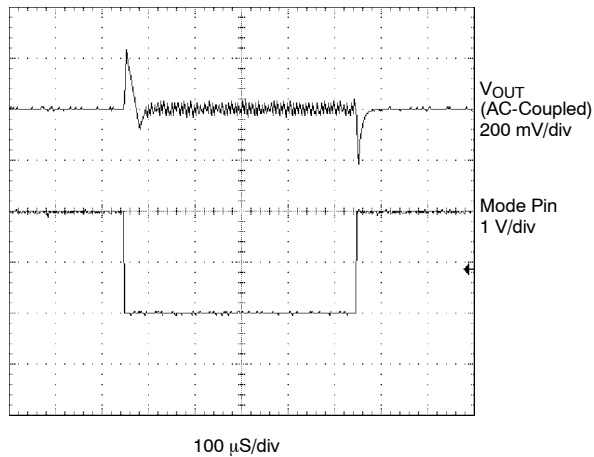

**TYPICAL LOAD TRANSIENT WAVEFORMS ( $V_{IN} = 3.6\text{ V}$ ,  $V_{OUT} = 1.9\text{ V}$ )**

Load Transient, Auto Mode,  $I_{LOAD} = 30$  to  $500\text{ mA}$ , MODE = LOW

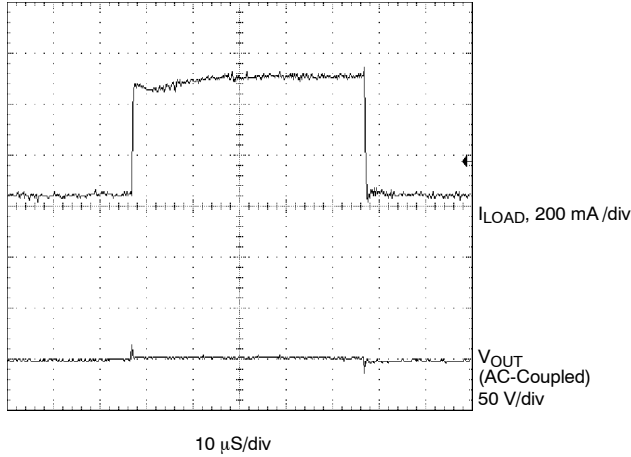

Load Transient, PWM Mode,  $I_{LOAD} = 30$  to  $500\text{ mA}$ ,  $L = 2.2\text{ }\mu\text{H}$ , MODE = HIGH

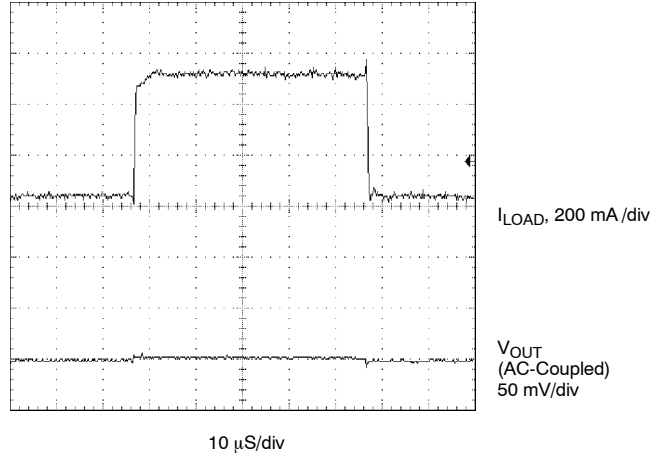

Load Transient (PSM Mode),  $I_{LOAD} = 30$  to  $150\text{ mA}$ ,  $L = 2.2\text{ }\mu\text{H}$

